



**PTAC Direct Sales, Inc.**  
**185 S. Kimball Ave., Suite 130**  
**Southlake, TX 76092**  
**877.454.7822 (T)**  
**877.647.6408 (F)**

[www.PTACdirect.com](http://www.PTACdirect.com)







## SUBMITTAL DATA

VIR24HP230V1R32AH / VIR24HP230V1R32AO  
 24000 BTU/H Wall Mounted Heat Pump System

Job Name	Location	Date
Purchaser	Engineer	
Submitted to	For	
Unit Designation	Schedule No.	

			
YBE1FBF	VIR24HP230V1R32AH	VIR24HP230V1R32AO	XE71 (Optional)

### GENERAL FEATURES

- AHRI Certificate: [215218912](#)
- High Efficiency DC Inverter Technology
- Compact and Quiet Design
- Auto-Clean Function on Indoor Unit
- Wireless Remote with LCD Display
- Wired Controller Options
- New R32 Refrigerant
- Composite Drain Pan
- Wi-Fi Included (Factory Installed)
- Low Ambient Cooling down to -20°F (Range -20°F to 122°F)
- Low Ambient Heating down to -22°F (Range -22°F to 86°F)
- Coil (Indoor and Outdoor) Copper Tube / Aluminum Fin
- Blue Colored Fin - 500 Hrs Salt Spray Tested

## SPECIFICATIONS, FEATURES & FUNCTION SUMMARY

SYSTEM TYPE			HEAT PUMP		FEATURES & FUNCTIONS SUMMARY	
Outdoor Model			VIR24HP230V1R32AO		Inverter Type	
Indoor Model			VIR24HP230V1R32AH		G20	
SYSTEM PERFORMANCE						
Cooling Capacity	Min - Max	Btu/h	3,340 - 28,660			
	Rated Capacity @95°F	Btu/h	22,000			
Heating Capacity	Min - Max	Btu/h	3,300 - 31,390			
	Rated Capacity @47°F	Btu/h	24,000			
	Rated Capacity @17°F	Btu/h	20,000			
	Rated Capacity @5°F	Btu/h	16,000			
SEER2			26.0			
EER2			13.65			
HSPF2			10.0			
COP @5°F			1.8			
Cooling Temperature Range		°F	-20 - 122			
Heating Temperature Range		°F	-22 - 86			
Refrigerant Type			R32			
INDOOR UNIT			VIR24HP230V1R32AH			
Air flow (Min - Max)		CFM	383 - 736			
Sound Pressure Level (Min - Max)		dB(A)	34 - 52			
Dehumidification		pt/hr	4.23			
External Dimensions (W x H x D)		in	42-21/64 x 13-7/64 x 9-11/16			
Package Dimension (W x H x D)		in	44-39/64 x 16-19/64 x 13-7/64			
Net Weight		lbs	35.3			
Gross Weight		lbs	41.9			
OUTDOOR UNIT			VIR24HP230V1R32AO			
Compressor Type			GREE G20 / SINGLE CYLINDER / 1 - STAGE INVERTER			
Sound Pressure Level		dB(A)	58			
External Dimensions (W x H x D)		in	37-23/32 x 25-63/64 x 15-53/64			
Package Dimension (W x H x D)		in	40-5/8 x 29-1/64 x 17-61/64			
Net Weight		lbs	92.6			
Gross Weight		lbs	102.5			
REFRIGERANT PIPING						
Refrigerant Charge - R32		oz	42.3			
Additional Charge		oz/ft	0.4			
Line Set Size (Liquid - Gas) - Flared Connections		in	1/4 - 5/8			
Pre-Charge Length		ft	25			
Pipe Length (Min - Max)		ft	10 - 131			
Max. Pipe Elevation		ft	82			
ELECTRICAL						
Power Supply			208-230V / 1Ph / 60Hz (Powered by the Outdoor Unit)			
Voltage Range (Min - Max)		VAC	187 - 253			
Rated Current - Cooling		A	13			
Rated Current - Heating		A	15.5			
MOCP		A	30			
MCA		A	22			
Main Power Wire Size		AWG	Per Local Code			
Interconnecting Wire Size		AWG	14 / 4			
Indoor Fan Type					Crossflow	
Ultra Low Frequency Torque Control					Yes	
Power Factor Correction					Yes	
Basepan With Electric Heater					Yes	
Indoor & Outdoor Fin Coating (Blue Fin)					Yes	
Intelligent Defrosting					Yes	
Intelligent Preheating					Yes	
Low Voltage Startup					Yes	
Memory/Power Failure Recovery					Yes	
Self Diagnosis					Yes	
Wired Controller Interface					Yes	
WiFi Included					Yes	
NEW! Easy Service Access					Yes	
Multi Fan Speeds					7 Speeds	
Indoor Unit Display					Yes	
Auxiliary Electrical Heater					No	
Ventilation (Outdoor Air)					No	
REMOTE CONTROLLER FUNCTIONS						
NEW! Auto Clean					Yes	
Auto Mode					Yes	
Auto Fan					Yes	
Auto Swing (Horizontal Auto Swing)					Yes	
Auto Swing - 180° (Vertical Auto Swing)					Yes	
Clock					Yes	
Dry Mode					Yes	
Dry Anti-Mildew (X-Fan) Mode					Yes	
Energy Saving Mode					Yes	
Dirty Filter Alert					Yes	
Fan Speed Control					Yes	
I Feel Function					Yes	
Privacy Lock					Yes	
Quiet Mode					Yes	
Room Temperature Display					Yes	
Sleep Mode					Yes	
3 Sleep Mode Options					Yes	
Timer Mode					Yes	
Turbo Mode					Yes	
Display On/Off Control					Yes	
Freeze Guard Mode					Yes	
Power Failure Mode					Yes	
Humidity Control					Yes	

## DIMENSIONS

### INDOOR UNIT

Unit: inch

VIR24HP230V1R32AH	
DIMENSIONS	
W	42 21/64
H	13 7/64
D	9 11/16
W1	7 7/32
W2	27 55/64
W3	7 1/4

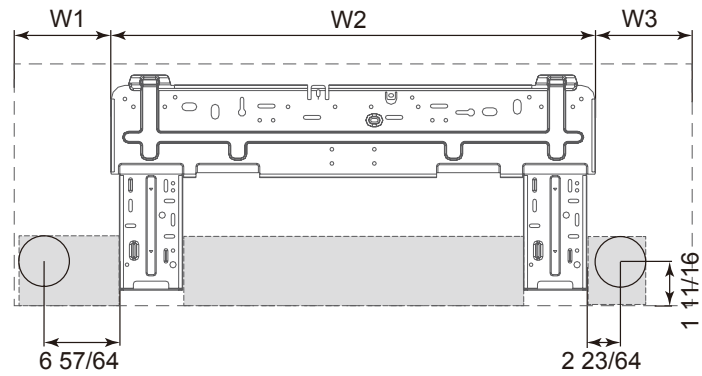
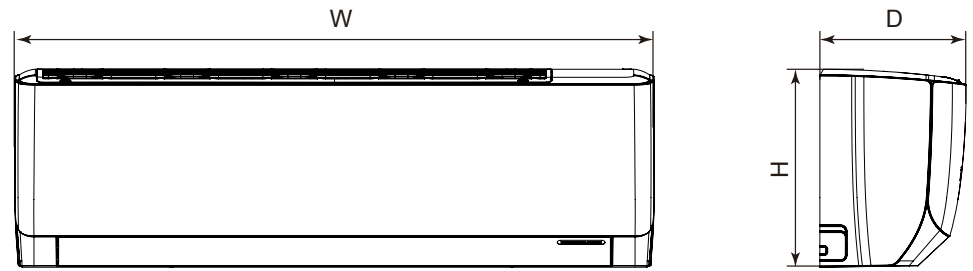

### OUTDOOR UNIT

Unit: inch

VIR24HP230V1R32AO
-------------------

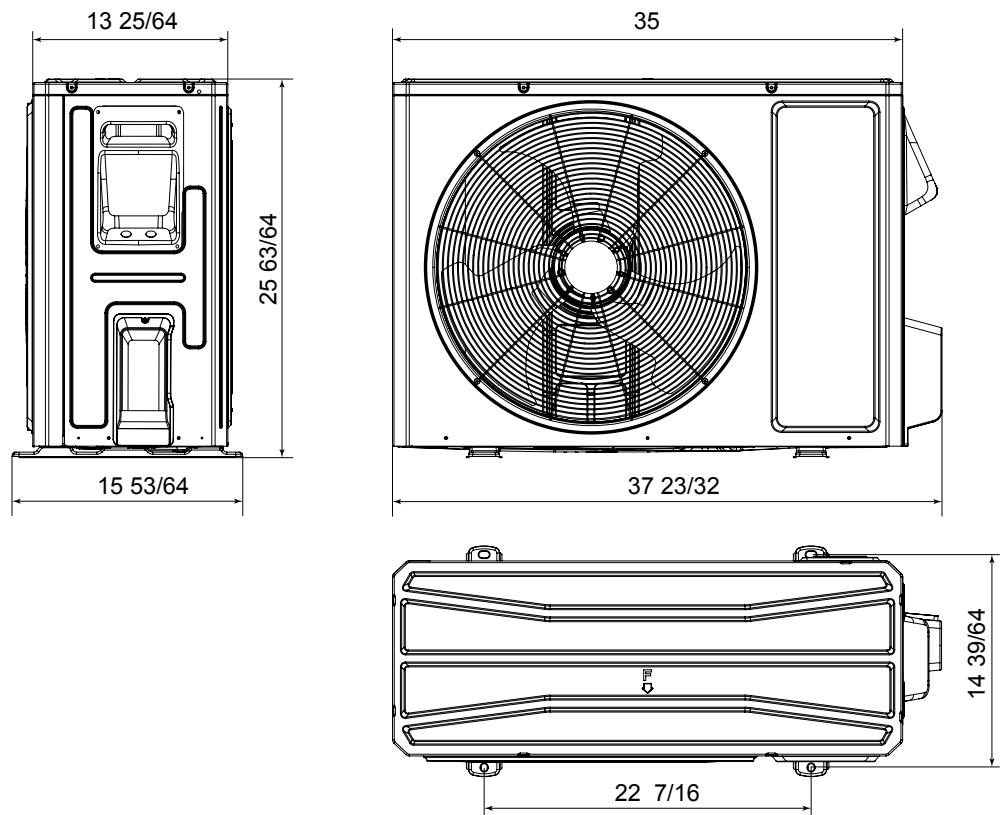

# CLEARANCES

## INDOOR UNIT Minimum clearance

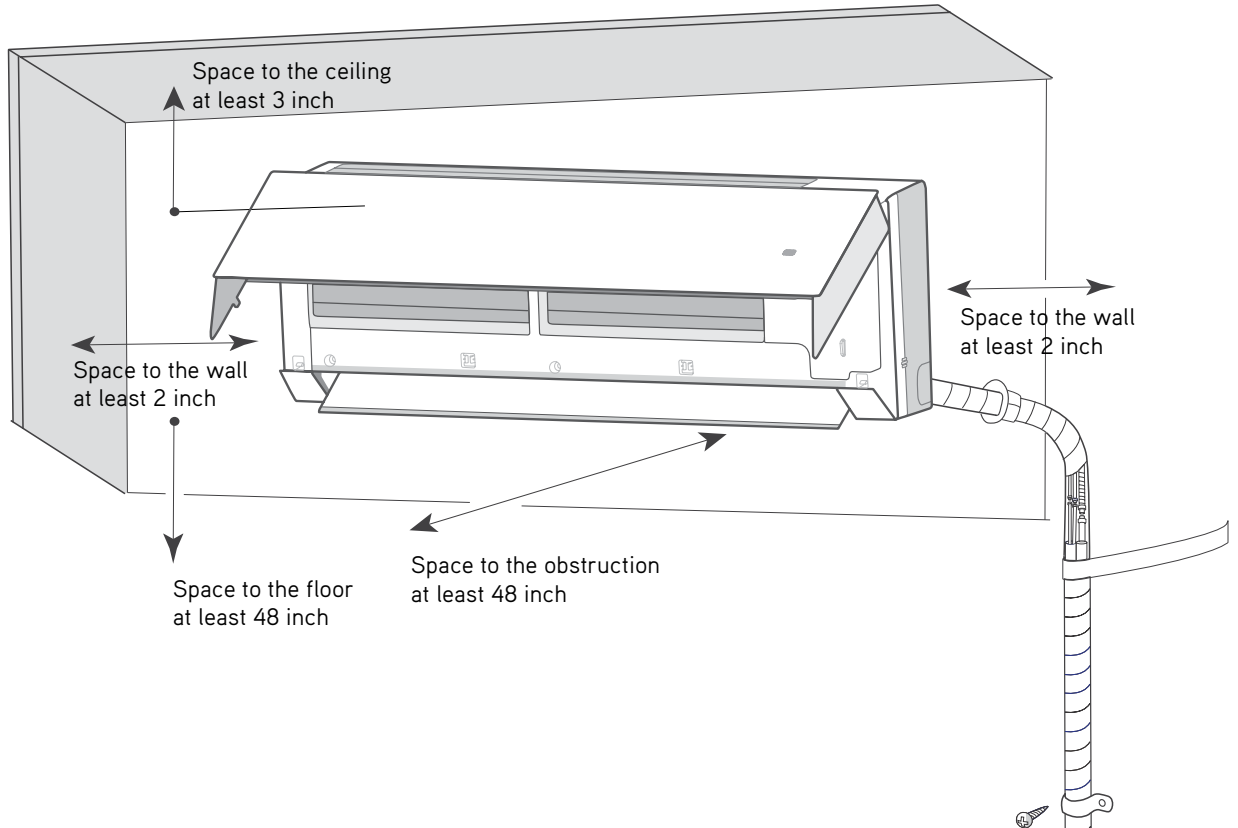

## OUTDOOR UNIT Minimum clearance

Diagram illustrating the mounting bracket for the outdoor unit. The bracket is shown with a 3 inch clearance to the wall.

**NOTE:**  
If bottom of the unit is free of airflow obstructions similar to the mounting bracket figure, the clearance to the wall on the back can be reduced to 3 inches.

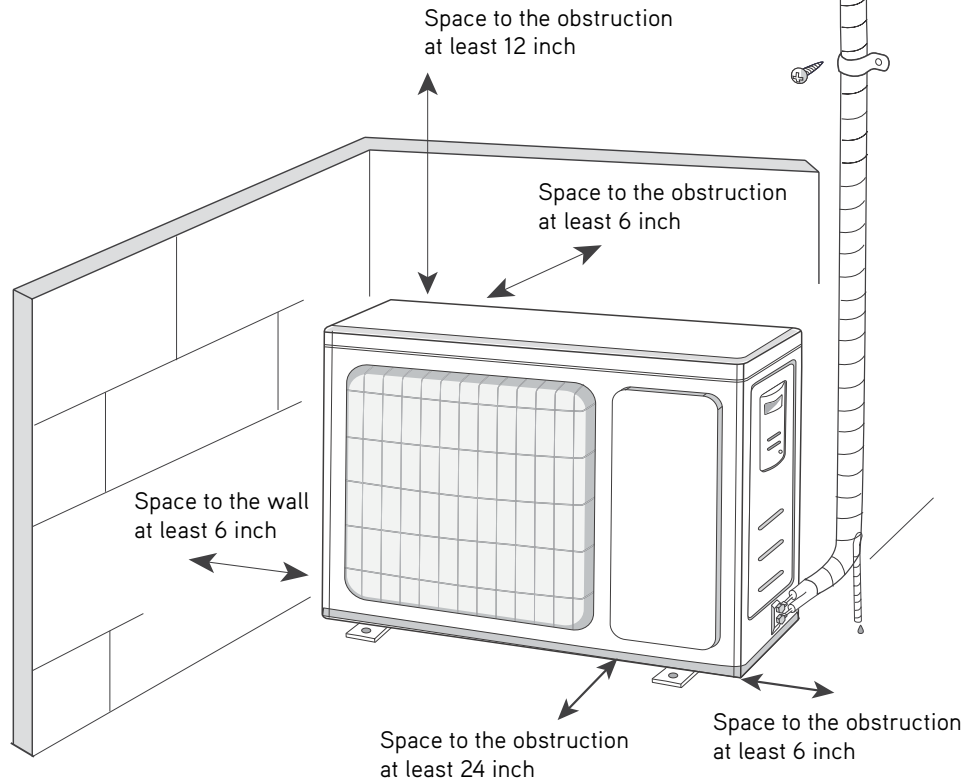

Specifications are subject to change without notice. Manufacturer reserves the right to discontinue or modify specifications or designs without notice or without incurring obligations. All Rights reserved.