

# VRPXEMWRT\* & DSSXEMWRT\* Wireless Series User Guide

Wireless Energy Management Thermostat  
with Built-in Occupancy Sensor and External  
HVAC Controller



**PTAC DIRECT SALES, INC.**  
**185 S. KIMBALL AVE., SUITE 130**  
**SOUTHLAKE, TX 76092**  
**877.454.7822**  
**[www.PTACdirect.com](http://www.PTACdirect.com)**

# Table of Contents

Introduction .....	6
SKUs Referenced in this Manual .....	7
Equipment Nomenclature .....	8
Installation Considerations.....	9
Network Installation.....	10
Connecting Wireless Receiver .....	11
Configuring Online Connection Kit.....	12
HVAC Controller Installation.....	13
Introduction.....	13
Using HVAC Controller to Power Wireless Thermostat (Optional).....	14
Using HVAC Controller's Dry Contacts to Control External Devices .....	15
Thermostat Installation.....	16
Mounting Thermostat to Wall.....	16
Optional Sensor Installation.....	17
Thermostat Details.....	18
Thermostat Buttons .....	18
Thermostat Screen.....	19
Understanding Display Screen Icons.....	19
Thermostat Configuration .....	20
Configuring Thermostat .....	20
Pairing Thermostat with HVAC Controller.....	21
Set MESH ID.....	22
Entering Room Number .....	23
Configuring Equipment Settings .....	24
Equipment Codes .....	24
Configuring Energy Saving Settings .....	25
Set Thermostat Clock.....	26

# Table of Contents

Testing Thermostat.....	27
Thermostat Maintenance .....	28
Replacing Thermostat Batteries.....	28
Thermostat Maintenance .....	29
Activating a Sensor.....	29
Pairing a Sensor .....	30
Verifying Sensor Connection Status and Unlinking Sensors.....	31
Configuring Functionality of Sensor.....	32
Completing Sensor Setup.....	34
Unit Specific Applications .....	35
Connecting HVAC Controller to VRP Unit.....	35
Replacing VRPXEMWRT2 Thermostat with VRPXEMWRT4* Thermostat.....	36
Configuring Equipment Settings for VRP .....	37
Configuring Equipment Settings for DSS.....	38
Installing FreshAire® PTAC (Cat 6 to FreshAire® PTAC ) .....	39
Configuring Equipment Settings for FreshAire® PTAC for digital control.....	40
Application Notes.....	41
Custom Energy Savings Settings .....	42
Accessing Custom Energy Savings Settings.....	42
Using Thermostat Settings Screens.....	43
Scheduler .....	45
Door Lock Integration .....	48
Demand Response .....	52
Lighting Integration.....	53
01 – FAN CONTROL MODE .....	56
02 – 1 <sup>ST</sup> STAGE DIFFERENTIAL - HEAT .....	57
03 – 2 <sup>ND</sup> STAGE DIFFERENTIAL - HEAT .....	58
04 – 1ST STAGE DIFFERENTIAL - COOL.....	59
05 – INCIDENTAL OCCUPANCY THRESHOLD.....	60

# Table of Contents

06 – NIGHT OCCUPANCY THRESHOLD .....	61
07 – FORCED 2ND STAGE HEATING .....	62
08 – NIGHT OCCUPANCY START .....	63
09 – NIGHT OCCUPANCY END .....	64
10 – TEMPERATURE RECOVERY TIME.....	65
11 – RECOVERY TEMPERATURE - HEAT .....	66
12 – TEMPERATURE SETBACK DELAY .....	67
13 – MINIMUM SETBACK TEMPERATURE - HEAT .....	68
14 – MAXIMUM SETBACK TEMPERATURE .....	69
15 – RECOVERY TEMPERATURE - COOL .....	70
16 – MINIMUM SET POINT.....	71
17 – MAXIMUM SET POINT .....	72
18 – TEMPERATURE CONTROL MODE.....	73
19 – AUTO CHANGEOVER SET POINT OFFSET .....	74
20 – SETBACK SET POINTS .....	75
21 – AUTO-RESTORE.....	76
22 – PLACEHOLDER SCREEN .....	77
23 – SETPOINT OVERSHOOT .....	78
24 – AUTOMATIC HUMIDITY CONTROL.....	79
25 – 2ND STAGE COOL DIFFERENTIAL .....	80
26 – SMART SETBACK .....	81
27 – HUMIDITY CONTROL THRESHOLD .....	82
28 – HUMIDITY CUTOFF TEMPERATURE.....	83
30 – ENERGY MANAGEMENT ON/OFF .....	85
31 – DOOR/WINDOW SHUT OFF DELAY .....	86
32 – AUTO FAN SPEED 1ST STAGE DIFFERENTIAL.....	87
33 – AUTO FAN SPEED 2ND STAGE DIFFERENTIAL .....	88
34 – TEMPERATURE CALIBRATION.....	89
35 – AUTOMODE TYPE.....	90
36 – HUMIDITY CONTROL OCCUPIED ROOM.....	91
37 – HEAT EQUIPMENT LOCKOUT .....	92
Troubleshooting .....	93
Restoring Factory Settings.....	93

# Table of Contents

APPENDIX 1 - Energy Saving Presets .....	94
APPENDIX 2 - Equipment Codes .....	96
APPENDIX 3 - Glossary .....	98
Warranty Information .....	99
Technical Specifications .....	100

# Introduction

The energy management thermostats deliver unprecedented energy savings without compromising the comfort of occupants.

An integrated occupancy sensor uses a combination of motion and thermal sensing technologies for accurate occupancy detection. Reliable occupancy detection allows for energy savings when rooms are unoccupied.

Energy saving presets eliminate the guesswork and make it easy to adjust the energy saving settings.

Fully configurable energy saving settings allow for customization of the thermostat settings to fit any situation.

Comprehensive configuration options ensure full compatibility with virtually any existing or emerging HVAC system with up to 4 heat and 2 cool stages.

Built-in wireless mesh-networking enables online management.

# Introduction

## SKUs Referenced in this Manual

This user guide includes instructions on how to install each of the following compatible SKUs.

Product Type	SKU(s)	Description
	VRPXEWRTA4*	Wireless Energy Management Thermostat PIR Occupancy Detection, VRP & PVH 12V, White
	VRPXEWRBT4*	Wireless Energy Management Thermostat PIR Occupancy Detection, VRP & PVH 12V, Black
	DSSXEWRTA4*	Wireless Energy Management Thermostat PIR Occupancy Detection, DSS, White
Network Equipment	EMOCT4	EMWRT3/4, DSSXEWR3/4, & VRPXEWR4* Online Connection Kit for Wireless Network Access**
Network Access	EMRAF4	Wireless Network Access Fee
Remote Sensors	EMRWOS4	Secondary Wireless Occupancy Sensor
	EMRTS4	Secondary Wireless Temperature Sensor
	EMRDS4	Wireless Door/Window Switch
Wall Plates	EMCWPA4	Thermostat Wall Plate White
	EMCWPB4	Thermostat Wall Plate Black
HVAC Controller	EMCC6R4	Stand-alone Wireless Control Card
Secondary Radio	EMZBU4	Embedded Zigbee/BLE Chip

\*'R' and 'U' SKUs also available.

\*\*Online Connection Kit is required to enable Wireless Web Based Remote Management. One (1) Online Connection Kit can accommodate up to 1,024 Networked Thermostats depending on property layout and configuration.

# Introduction

## Equipment Nomenclature

Before you begin installing this equipment, we recommend you familiarize yourself with the various components that may be included in your shipment.



EM Thermostat & HVAC Controller



Online Connection Kit



Occupancy Sensor



Door/Window Sensor

# Introduction

## Installation Considerations

Selecting the appropriate installation location of the thermostat and any accessories is crucial to the proper operation of your energy management system. The following guidelines should be adhered to in all cases;

THE THERMOSTAT'S OCCUPANCY SENSOR SHOULD FACE THE BED AREA OF THE ROOM OR THE AREA WHERE THE OCCUPANT WILL SPEND THE MOST TIME.

THE THERMOSTAT MUST NOT BE INSTALLED IN THE VICINITY OF LARGE METAL STRUCTURES OR SURFACES INCLUDING METAL AIR DUCTING THAT MAY BE IN THE WALL. LARGE METAL STRUCTURES BETWEEN THE THERMOSTAT AND CONTROL CARD AND/OR THE ONLINE CONNECTION KIT SUCH AS METAL CABINETS OR DOORS/ ELEVATOR SHAFTS SIGNIFICANTLY REDUCE THE RANGE OF THE WIRELESS SIGNAL AS THEY DEFLECT THE SIGNAL AND THEY DON'T ALLOW IT TO PASS THROUGH THEM, THUS REDUCING THE SIGNAL STRENGTH BETWEEN THE DEVICES MENTIONED.

DO NOT INSTALL THE THERMOSTAT NEAR WINDOWS OR DOOR VENTS, ON AN EXTERIOR WALL, ABOVE OR BELOW SUPPLY VENTS, OR OTHER LESS OCCUPIED AREAS.

# Network Installation

## NOTICE

TO ENABLE NETWORKING CAPABILITIES OF THE THERMOSTAT, REFER TO THE "NETWORK INSTALLATION" SECTION OF THIS MANUAL.

BEFORE STARTING THE INSTALLATION OF THE NETWORKED THERMOSTATS, ENSURE THE ONLINE CONNECTION KIT IS CONNECTED TO THE INTERNET.

CONFIRM THE ONLINE CONNECTION KIT IS COMMUNICATING PROPERLY WITH THE CLOUD SERVICE BY CALLING TECHNICAL SUPPORT AT 1 877 318 1823.

THE ANTENNA MODULE MUST BE INSTALLED WITHIN 100FT FROM THE FIRST 2 TO 3 THERMOSTATS, AND MUST NOT BE INSTALLED NEAR LARGE METAL STRUCTURES OR SURFACES.

TO PREVENT POWER RELATED ISSUES, PLUG THE SERVER INTO A UPS (UNINTERRUPTED POWER SUPPLY) UNIT.

THE ANTENNA(S) USED FOR THIS TRANSMITTER MUST NOT BE CO-LOCATED OR OPERATING IN CONJUNCTION WITH ANY OTHER ANTENNA OR TRANSMITTER AND MUST BE INSTALLED TO PROVIDE A SEPARATION DISTANCE OF AT LEAST 20CM FROM ALL PERSONS.

# Network Installation

## Connecting Wireless Receiver

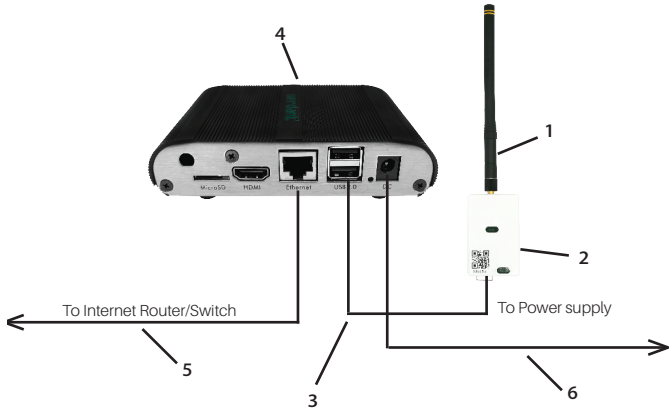

1. Screw Antenna (1) onto Wireless Receiver (2)
2. Connect Wireless Receiver (2) to Server (4) using supplied USB cable (3)
3. Affix Wireless Receiver (2) to wall with double sided adhesive tape
4. Orient Antenna (1) to point upwards to the closest room in which a thermostat will be installed
5. Connect Server (4) to the LAN port with the supplied RJ-45 cable (5)
6. Plug Server (4) into electrical outlet with power cord (6)

# Network Installation

## Configuring Online Connection Kit

1. Ensure Online Connection Kit is receiving an IP from a DHCP server.  
NOTE: it is not recommended to use a public IP
2. Ensure MAC address is properly Whitelisted if it needs to bypass a login (splash) page to reach the internet  
NOTE: MAC address is printed on a white sticker on bottom of Online Connection Kit.
3. If behind a firewall, OUTBOUND ports 22, 80, and 443 must be allowed for the Online Connection Kit. No INBOUND ports are required for this device unless specific options are requested.

For any technical support on Networking and Connections, please call 877-318-1823

# HVAC Controller Installation

## Introduction

HVAC Controllers enable wireless thermostat control of most HVAC units. The HVAC Controller has relay 24VAC outputs, analog 0-10VDC outputs, and digital data (RS485) outputs to allow for control of virtually any HVAC unit.

The illustration below indicates the various ports available on the HVAC Controller. Refer to the appropriate page in this manual for wiring instructions for your specific HVAC unit.

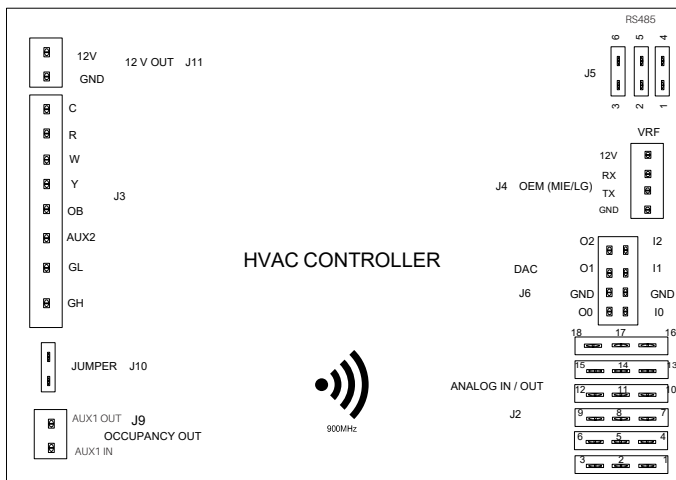

# HVAC Controller Installation

## Using HVAC Controller to Power Wireless Thermostat (Optional)

The J11 port on the HVAC Controller may be used to supply 12VDC power to a wireless thermostat, if desired.

Use the supplied wire harness to connect the J11 port to the back of the wireless thermostat

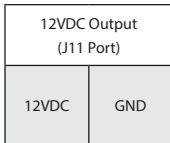

# HVAC Controller Installation

## Using HVAC Controller's Dry Contacts to Control External Devices

The J9 port on HVAC Controller can be used as a dry contact for control of external devices such as lighting relays and dampers. Refer to application notes for more information.

1. Connect jumper on J10 to create a wet contact supplying power from R&C.

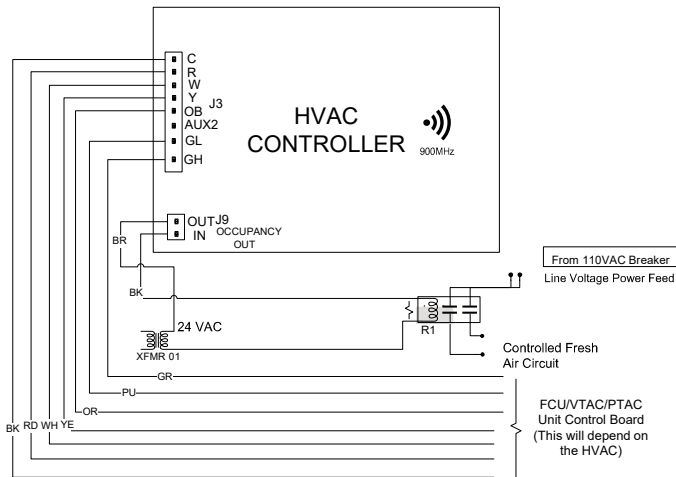

# Thermostat Installation

## Mounting Thermostat to Wall

1. Select appropriate installation location for thermostat per below:

THE THERMOSTAT'S OCCUPANCY SENSOR SHOULD FACE THE BED AREA OF THE ROOM OR AREA WHERE OCCUPANT WILL SPEND THE MOST TIME.

THE THERMOSTAT MUST NOT BE INSTALLED IN THE VICINITY OF LARGE METAL STRUCTURES OR SURFACES INCLUDING METAL AIR DUCTING. DO NOT INSTALL THERMOSTAT NEAR WINDOWS OR DOORS WHICH MAY ALLOW A DRAFT, ON AN EXTERIOR WALL, ABOVE OR BELOW SUPPLY VENTS, AND OTHER LESS OCCUPIED AREAS.

2. If using a wall plate, place it over hole in wall left from previous thermostat and mark two locations for drilling holes
3. Place thermostat on wall in installation location and mark location for drilling holes for two mounting screws
4. Drill two 3/16" holes in wall and insert two wall anchors
5. Use two screws to securely mount thermostat to wall

DO NOT OVER TIGHTEN THE BACK PLATE TO THE WALL. FOR UNEVEN SURFACES INSTALL A WALL PLATE.

6. Insert two AA alkaline batteries in thermostat. The thermostat can also be powered with 12VDC or 24VAC

# Optional Sensor Installation

1. Select appropriate installation location
2. With faceplate removed, place sensor on wall in installation location and mark location for drilling holes for two mounting screws

OCCUPANCY SENSORS SHOULD FACE THE DESIRED OCCUPANCY DETECTION AREA.

3. Drill two 3/16" holes in wall and insert two wall anchors
4. Use two screws to securely mount sensor to the wall
5. Insert one AAA alkaline battery into compartment (wireless sensors only)

# Thermostat Details

## Thermostat Buttons

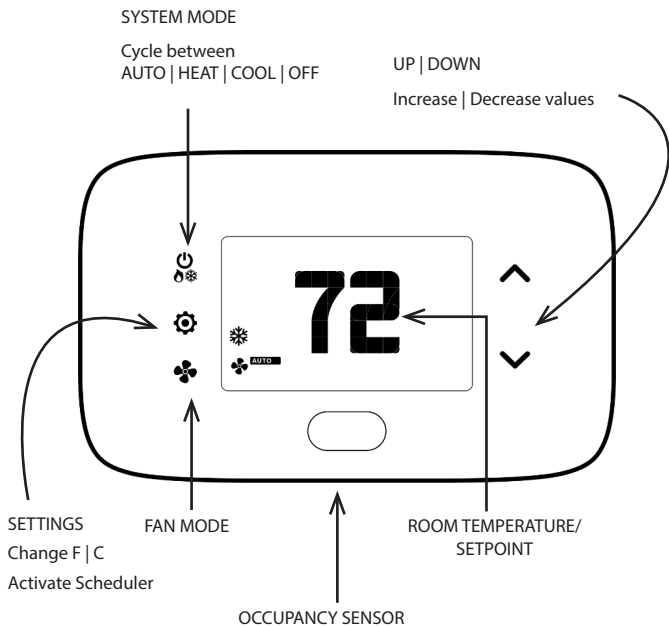

\*In AUTO Mode, cycle between ON | OFF. In MANUAL mode, Cycle between OFF | HEAT | COOL

# Thermostat Screen

## Understanding Display Screen Icons

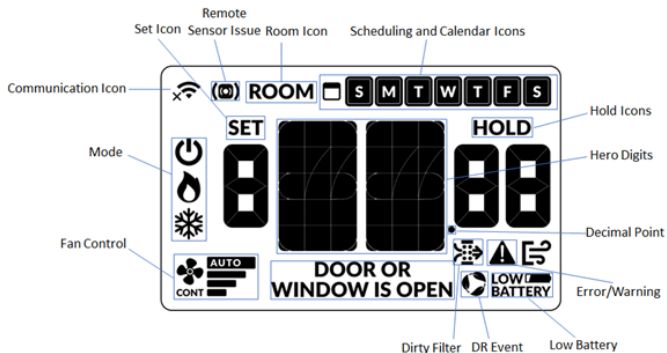

# Thermostat Configuration

## Configuring Thermostat

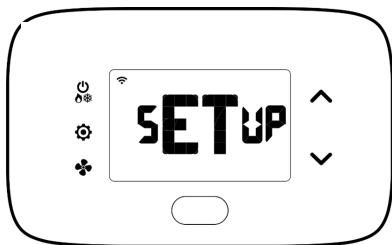

Prerequisites: During installation training with your support agent you will be provided with: Mesh ID (if Networked, provided by Technical Support), Room Number, Time, and Equipment Code. For VRP & PVH 12V insert one jumper into function selection pins 1 and 2 and another jumper in pins 4 and 5 at J5 on the control card.

To start with the configuration process, remove faceplate and insert 2 AA batteries.

NOTE: Press and hold FAN and SYSTEM MODE buttons.

Turn on thermostat and HVAC unit to activate setup screen (shown above) and complete the below settings shown the following pages:

1. Pair thermostat with HVAC Controller
2. Set MESH ID (only for Networked Systems)
3. Enter room number
4. Enter equipment code
5. Configure energy saving settings
6. Set thermostat clock
7. Enable/Disable Scheduler

NOTE: If the thermostat does not display SETUP when first powering the device, then it has already been paired to an HVAC Controller. To exit configuration menu at any time, press the SYSTEM MODE button.

# Thermostat Configuration

## Pairing Thermostat with HVAC Controller

Each wireless thermostat must be paired with an individual HVAC Controller during installation. The thermostat will search for the closest HVAC Controller and display the unique HVAC Controller ID. The HVAC Controller ID is located on the case of the HVAC Controller. Only install one room at a time.

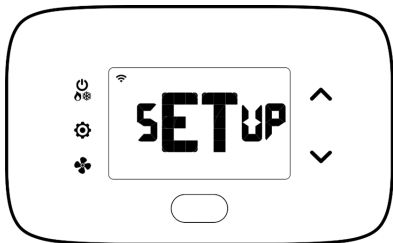

Press SETTINGS button. The thermostat will initiate a thirty (30) second countdown with a blinking connectivity icon before displaying the closest HVAC Controller ID

1. Verify HVAC controller ID found by thermostat matches the ID's last 5 digits listed on HVAC controller in the same room
2. Press SETTINGS button to pair thermostat with HVAC Controller displayed on the screen. The screen will display SUCC when the HVAC Controller has been paired successfully. If the HVAC Controller ID displayed on the screen is incorrect, press the FAN button to reject it and follow the bolded section below
3. If pairing is successful, wait 5-10 seconds and press SETTINGS button to advance to the Mesh ID configuration page

- If the HVAC controller ID displayed **does not match**, press the down button to see what other controllers are trying to connect with the thermostat. Keep pressing until you identify the matching controller number.
- If **no controller ID is found**, FAIL will appear on the screen. Press the ON | OFF button to get back to the initial setup screen and repeat procedure.

# Thermostat Configuration

Set MESH ID (FOR NETWORKED SYSTEMS ONLY)

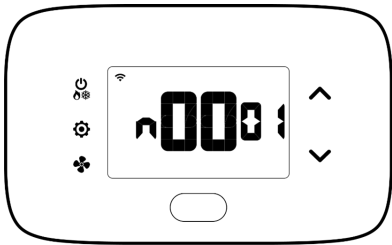

For networked installations, a unique MESH ID is associated to each Online Connection Kit and is provided by your technical support agent during the installation training (also be found labeled on device).

For properties using a single Online Connection Kit, each thermostat may be linked to MESH ID 0001. For properties requiring multiple Online Connection Kits, each thermostat should be linked to the MESH ID of the closest Online Connection Kit.

1. Press UP | DOWN buttons to increase or decrease value
2. Press FAN button to advance to next digit
3. Press SETTINGS button to advance to next step

# Thermostat Configuration

## Entering Room Number

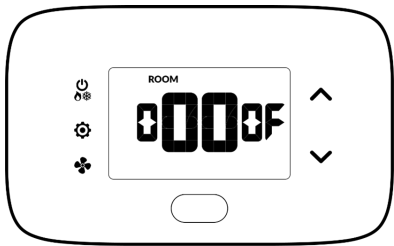

Enter room number by changing characters on screen. Available characters include digits 0-9 and letters A-F. To distinguish between two or more thermostats in the same unit, enter as follows:

Thermostat 1: 00100

Thermostat 2: 0100A

1. Press UP | DOWN buttons to increase or decrease the value
2. Press FAN button to advance to the next digit
3. Press SETTINGS button to advance to next menu

Entering room number correctly is crucial for proper operation of thermostats with online management/networking.

# Wall Controller Configuration

## Equipment Codes

Enter equipment code by changing digits on the screen.

Model Description	Equipment Code
VRP/FreshAire 12 V Control*	6603
DSS	6643

\* PTAC PVH models can connect either AC or DC control wiring:

- PVH that finishes in -A connects to 24 V and runs with equipment code 1012.
- PVH that finishes in -B might connect to 12 V and 24 V depending on the wiring connection.
- If 12 V connected, runs on equipment code 6603.
- If 24 V is connected, runs on equipment code 1012.

For more information on installation of the units see below sections:

- VRP unit-specific installation (page 35)
- DSS unit-specific installation (page 39)
- FreshAire PTAC unit-specific installation (page 39)

# Thermostat Configuration

## Configuring Energy Saving Settings

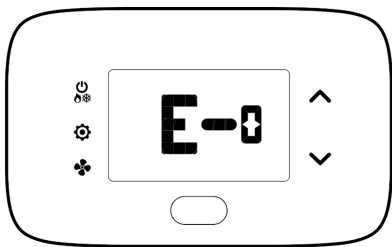

1. Press UP | DOWN buttons to increase or decrease energy savings preset
2. Press SETTINGS button to advance to next menu

\*default setting

Preset	Energy Savings Presets
E-0*	Energy Savings Off - No Temperature Setback
E-1	Lowest Energy Savings
E-2	Lower Energy Savings
E-3	Standard Energy Savings
E-4	Higher Energy Savings
E-5	Highest Energy Savings

Please refer to Appendix 1 for more details on these presets

# Thermostat Configuration

## Set Thermostat Clock

Set thermostat clock to current time in 24h format.

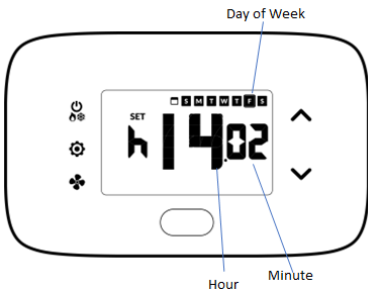

1. Press UP | DOWN buttons to increase or decrease digits
2. Press FAN button to advance to next digit
3. Press SETTINGS button once to go to current room temperature screen.
4. Setup is now complete

SETTING CORRECT TIME IS CRUCIAL FOR PROPER OPERATION OF THERMOSTAT. TIME UPDATES AUTOMATICALLY IF CONNECTED TO ONLINE CONNECTION KIT.

# Thermostat Configuration

## Testing Thermostat

Following thermostat configuration, test if the thermostat is controlling the HVAC unit.

1. Ensure thermostat is powered and faceplate is affixed
2. Press DOWN button to change temperature set point below current room temperature to confirm thermostat initiates cooling
3. Press UP button to change temperature set point above current room temperature to confirm thermostat initiates heating
4. Change fan speed by touching FAN button to verify thermostat is controlling fan speed

# Thermostat Maintenance

## Replacing Thermostat Batteries

The low battery indicator is displayed on thermostat screen when necessary to replace batteries.

Under normal operating conditions, new brand-name alkaline batteries last for approximately 18 months. Replace batteries every 16 months to ensure continuous thermostat operation.

1. Remove thermostat cover
2. Replace two AA alkaline batteries
3. Re-affix thermostat cover
4. Press SYSTEM MODE button to start thermostat.

NOTE: Thermostat maintains all previous configuration settings in non-volatile memory.

# Thermostat Maintenance

## Activating a Sensor

1. Remove the faceplate from the sensor to be paired
2. Insert two AAA alkaline batteries into each sensor
3. Press button inside sensor to make sensor discoverable
4. Navigate to “Pairing a Sensor” on page 30

NOTE: The sensor(s) will remain discoverable for five (5) minutes after pressing the button inside the device. If the pairing process has not been completed within five (5) minutes, push button inside sensor again.

# Configuring & Managing Accessories

## Pairing a Sensor

Ensure thermostat and HVAC unit are powered and thermostat faceplate is removed. The thermostat configuration screens have a 30-second time-out. If no action is taken within this time, the thermostat exits configuration settings.

1. Press and hold SYSTEM MODE and FAN buttons on thermostat to access Mesh ID screen
2. Press and hold SYSTEM MODE and FAN buttons again until type appears
3. Press SETTINGS button until SENS appears

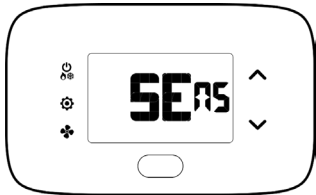

4. Press FAN button on thermostat to initiate pairing of a new sensor ,or, press SETTINGS to manage existing sensors. This will initiate a 10 second countdown and display the last 5 digits of the sensor ID(s) discovered during the pairing procedure.
5. Use UP | DOWN buttons to toggle between discovered sensors
6. Ensure unique device ID displayed on screen matches unique device ID of sensor to configure
7. Press SETTINGS button when Add appears
8. Press SETTINGS button to pair selected sensor to HVAC Controller
9. Verify SUcc shows on screen

NOTE: If pairing fails, press ON | OFF button to exit and perform procedure again.

# Configuring & Managing Accessories

## Verifying Sensor Connection Status and Unlinking Sensors

NOTE: Thermostat and HVAC unit must be powered

1. Remove faceplate from thermostat
2. Press and hold SYSTEM MODE and FAN buttons until MESH ID appears on the screen
3. Press and hold SYSTEM MODE and FAN buttons again until type appears on screen
4. Press SETTINGS button again until SENS appears on the screen
5. Press SETTINGS button. The Thermostat will initiate a 10 second countdown before displaying the number of linked sensors currently communicating with the thermostat (e.g. 02.02 means 2 out of 2 linked sensors is communicating with thermostat)



6. Press SETTINGS button to display the first linked sensor and UP | DOWN buttons to cycle through linked sensors
7. After selecting sensor to be unlinked, press and hold CONFIG button. The thermostat will initiate a 10 second countdown before displaying the total number of linked sensors
8. Press SYSTEM MODE button to exit this configuration menu
9. Press button on the sensor for 3 seconds until a yellow light turns on. The sensor is now reset and can be paired to the thermostat again if necessary.

# Configuring & Managing Accessories

## Configuring Functionality of Sensor

The thermostat allows the user to choose the functionality of a sensor. Use the table below to configure the desired functionality. For example, if sensor is intended to be used as Occupancy Sensor, OCC value must be set to 1.

NOTE: OCC default setting = 0

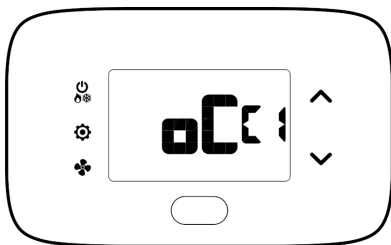

1. Press SETTINGS button to select sensor
2. Press SETTINGS button to move to Occupancy Sensor configuration screen OCC and use the UP | DOWN buttons to increase or decrease digit according to below table

Trailing Digit Value	OCC cx (Occupancy Sensor)	dsx (Door Switch)	rtx (Temperature Sensor)
0*	Disabled	Disabled	Disabled
1	Enabled	Normally Closed	Master
2		Normally Open	Average

# Configuring & Managing Accessories

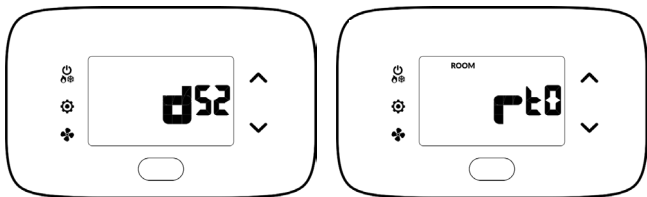

3. Press SETTINGS button to configure Door Switch functionality (dsx). Door switch functionality should be set to Normally Open (NO) or Normally Closed (NC) depending on reed switch
4. Press SETTINGS button to configure Temperature Sensor functionality (rtx)
5. Press SETTINGS button to move to ADD screen
6. Press FAN button to finalize pairing

# Configuring & Managing Accessories

## Completing Sensor Setup

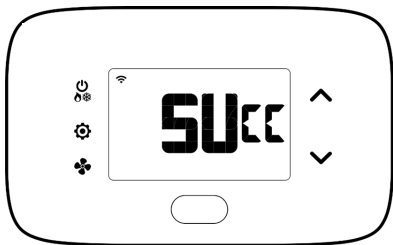

The thermostat will countdown from thirty (30) seconds. If the sensor has successfully paired, the thermostat will display **SUCC**. If the sensor did not pair successfully, the display will read **FAIL**, and the procedure must be repeated.

1. Press **SYSTEM MODE** button to exit sensor setup screen
2. Repeat Sensor setup as many times as necessary

# Unit Specific Applications

## Connecting HVAC Controller to VRP Unit

1. Connect harness to HVAC Controller
2. Connect other end of harness into the RJ45 socket on the VRP
3. Insert the provided jumpers into pin terminals 1-2 and 4-5 of the J5 port
4. Ensure that that the control card NOT installed inside the VRP chassis

Wire Color	Terminal Letter
ORANGE	V+
BROWN	D+
BLUE	D-
GREEN	V-

WIRE COLOR	LABEL
Blue	Connection 1 V+ Orange
Green	Connection 2 D- Blue
White/Orange	Connection 3 D+ Brown
White/Blue	Connection 4 V- Green

HVAC Controller Side  VRP Side

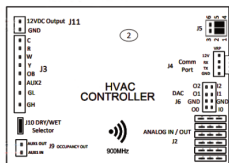

## Replacing VRPXEMWRT2 Thermostat with VRPXEMWRT4\* Thermostat (PVH Models only)

1. Color coordination/coding is the same between the two devices.
2. D+ & D- are reversed between the VRPXEMWRT2 and VRPXEMWRT4\*.
3. Wires for D+ and D- can be reversed at the control card OR at the VRP unit.

VRPXEMWRT2

WIRE COLOR	LABEL
Orange	Connection 1 V+ Orange
Green/White	
Blue	Connection 3 D- Blue
Brown/White	
Brown	Connection 2 D+ Brown
Blue/White	
Green	Connection 4 V- Green
Orange/White	
Ground Shield Wire	GND

VRPXEMWRT4\*

WIRE COLOR	LABEL
Blue	Connection 1 V+ Orange
Brown/White	
Green	Connection 2 D- Blue
Orange	
White/Orange	Connection 3 D+ Brown
White/Green	
White/Blue	Connection 4 V- Green
Brown	

OR

WIRE COLOR	LABEL
Orange	Connection 1 V+ Orange
Green/White	
Brown	Connection 2 D+ Brown
Blue/White	
Blue	Connection 3 D- Blue
Brown/White	
Green	Connection 4 V- Green
Orange/White	
Ground Shield Wire	GND

# Unit Specific Applications

## Configuring Equipment Settings for VRP

Enter equipment code 6603 by changing digits on screen.



1. Press FAN button to advance to the next equipment setting
2. Press UP | DOWN buttons to increase or decrease value to 6603
3. Press SETTINGS button to advance to next menu



4. After entering equipment code, the thermostat requires the source of the temperature reading. Temperature can be sensed by the thermostat (TS) or by conditioning unit (AC) if a conditioning unit supports the option of reading temperature.
5. Press UP | DOWN buttons to select TS (preferable over AC).

# Unit Specific Applications

## Configuring Equipment Settings for DSS

Enter equipment code 6643 by changing digits on screen.

1. Mount the HVAC controller next to the DSS head.
2. Disconnect the WiFi module in the DSS Pro/Premier wall-mount or cassette and connect to control card (J4 port) using the other end of the wire harness provided
3. Press FAN button to advance to the next equipment setting
4. Press UP | DOWN buttons to increase or decrease value to 6603
5. Press SETTINGS button to advance to next menu
6. After entering equipment code, the thermostat requires the source of the temperature reading. Temperature can be sensed by the thermostat (TS) or by conditioning unit (AC) if a conditioning unit supports the option of reading temperature.
7. Press UP | DOWN buttons to select AC for DSS.



# Unit Specific Applications

Installing FreshAir® PTAC (Cat 6 to FreshAir® PTAC )

NOTE: FreshAir® PTAC models with a SKU ending in 'A' are only compatible with 24V. FreshAir® PTAC models with a SKU ending in 'B' and above are compatible with VRPXEMWRT\* thermostat.

1. Connect one end of Cat6/Cat5 wire to FreshAir® PTAC using RJ45 port on PTAC unit using harness 142-00041-00.
2. Insert the provided jumpers into pin terminals 1-2 and 4-5 of the J5 port



WIRE COLOR	LABEL
Blue Brown/White	Connection 1 V+ Orange
Green Orange	Connection 2 D- Blue
White/Orange White/Green	Connection 3 D+ Brown
White/Blue Brown	Connection 4 V- Green



# Unit Specific Applications

Configuring Equipment Settings for FreshAir® PTAC for digital control

Enter equipment code 6613 by changing digits on screen.



1. Press FAN button to advance to the next equipment setting
2. Press UP | DOWN buttons to increase or decrease value to 6613
3. Press SETTINGS button to advance to next menu



4. After entering equipment code, the thermostat requires the source of the temperature reading. Temperature can be sensed by the thermostat (TS) or by conditioning unit (AC) if a conditioning unit supports the option of reading temperature.
5. Press UP | DOWN buttons to select TS (preferable over AC).

# Application Notes

A comprehensive list of published application notes can be found at [www.verdant.co/resources/application-notes](http://www.verdant.co/resources/application-notes).

Applications include (among others):

1. Energy Savings Settings
2. Scheduler
3. Door-lock ZigBee Integrated Solution
4. Demand Response
5. Hilton PEP
6. IHG Studio
7. Occupancy Based Lighting Control
8. Advanced Lighting Application: ZigBee Controlled Switch and socket from LEVITON

# Custom Energy Savings Settings

If you do not want to use one of the energy saving presets detailed in Appendix 1, you can enter the custom energy savings settings.

## Accessing Custom Energy Savings Settings

1. Ensure thermostat is powered and faceplate removed
2. Press and hold CONFIG button to access Mesh ID screen
3. Press SETTINGS button to navigate to Energy Saving Settings screen
4. From Energy Savings Settings screen, press and hold CONFIG button until first custom energy saving settings screen appears

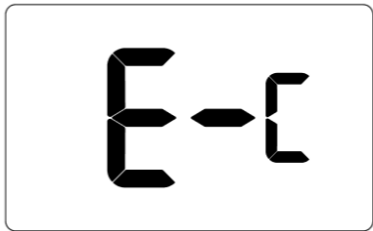

# Custom Energy Savings Settings

## Using Thermostat Settings Screens

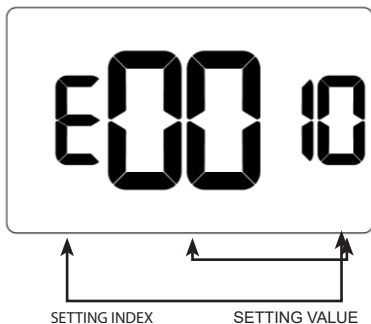

1. Use UP | DOWN buttons to select desired index setting
2. Press CONFIG button to edit value of index setting
3. Use the UP | DOWN buttons to change setting value (see Custom energy saving settings section for more info and Min-Max values)
4. Press FAN button to temporarily store setting value
5. Press FAN button to save profile and exit Custom Energy Savings Settings
6. To discard the changes, press ON | OFF button at any time

## Custom Energy Savings Settings



Default value: enabled  
Range: 7 days

Allows for setting of cooling and heating set points at varying times throughout the day.

The scheduler is enabled by default and let's the user set cooling and heating setpoints for different times for each day of the week.

The scheduler allows the thermostat to store up to 6 events for each day (7 days). Events #5 and #6 should be enabled via the web.

# Custom Energy Savings Settings

## Scheduler

Firmware version 1130 and higher is required for Scheduler feature.

1. Ensure thermostat is powered and operational

NOTE: Below illustration is an example. Temperature and fan mode can differ.



2. Press SETTINGS button until temperature value shows
3. Press SETTINGS again to activate scheduler and show current status ( n or y)
4. Use the UP | DOWN button to select desired status



# Custom Energy Savings Settings

5. Press SETTINGS button to navigate to first event of the week. Use Up / Down arrows to set event time.

NOTE: below example shows setting for second event.



6. Press SETTINGS button to display Set and press Fan button to select necessary day of the week. Press SETTINGS button when correct day is selected.

NOTE: go to Step 5 immediately after selecting correct day.



# Custom Energy Savings Settings

7. Use UP | DOWN buttons to set cooling temperature to desired setpoint and press SETTINGS button.
8. Use UP | DOWN arrows to set heating setpoint.  
NOTE: press ON | OFF button at anytime to exit scheduler menu.

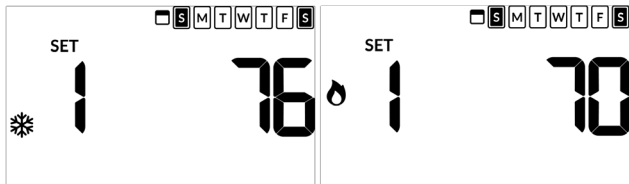

9. Repeat Step 5 until all desired events are scheduled

# Custom Energy Savings Settings

## Door Lock Integration

Door Lock integration can be via 1-Way Communication or 2-Way Communication.

- 1-Way application: Door locks must be networked and communicating with a Door Lock Management System for thermostat integration
- 2-Way application: thermostat acts as the network. Door locks are not required to be networked. A ZigBee coordinator is also required for wired / wireless integration

NOTE: integration with dormakaba requires ebox and dorma server set-up and communicating.

NOTE: remove faceplate from thermostat before starting procedure

1. Press and hold CONFIG button until MESH ID appears
2. Press and hold CONFIG button until type appears
3. Press FAN button until Select shows on screen

NOTE:

- Wireless: countdown appears to confirm pairing to control card
- Wired: no countdown



# Custom Energy Savings Settings

4. Press DOWN button to display Add and then press SETTINGS button to display select list.



5. Press DOWN button until desired lock platform shows (oni or kaba) and then press SETTINGS (below example only)



6. Allow countdown to complete until screen displays Found[1-8].



# Custom Energy Savings Settings

- Use DOWN button to scroll through found devices with Eul\_[lockid]\_255 format.

## NOTE:

- Dorma locks display as lock's respective short ZigBee ID
- Onity locks display as lock's respective serial number. Press SETTINGS to select and display -cFg\_[lockid]\_255

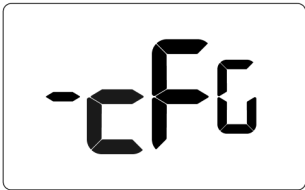

- Press DOWN one time to display the 1tag screen. Then press SETTINGS to display t----

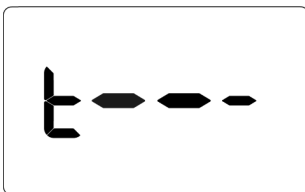

# Custom Energy Savings Settings

- Use UP | DOWN buttons to select a tag number (typically 001) and then press SETTINGS to set and display `cfg_[lockid]_[tag]`

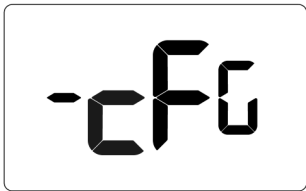

- Press DOWN button 2 times to display Acc and then press SETTINGS to accept and re-display Found screen



- Press ON | OFF button to exit the menu system.

# Custom Energy Savings Settings

## Demand Response

Demand Response (DR) is a resource for balancing power supply and demand by allowing consumers options to reduce or shift their energy consumption away from peak periods.

### How it works

- **Enroll:** Tenant or Property owner opt in to receive DR events
- **Integration with Aggregators:** DR aggregators linked to the property's utility company integrate with APIs allowing automatic transmission of DR events to thermostats
- **Active DR Event Indicator:** Thermostats display a distinctive icon alerting tenants and guests a DR event has been sent
- **Opt-Out Option:** Tenants and Guests may opt out of DR events by adjusting the setpoint

NOTE: DR requires firmware 1130 or later

# Custom Energy Savings Settings

## Lighting Integration

The thermostat uses built-in infrared motion sensors in conjunction with a wired occupancy sensor to scan a room for occupancy. An auxiliary output provides a binary signal according to real-time occupancy status in the room.

The auxiliary output is wired to a 24VAC relay installed on the lighting circuit; closing the circuit when the room is occupied, and automatically shutting off power to the circuit after occupancy is no longer detected.

A RIB2401B relay is recommended.

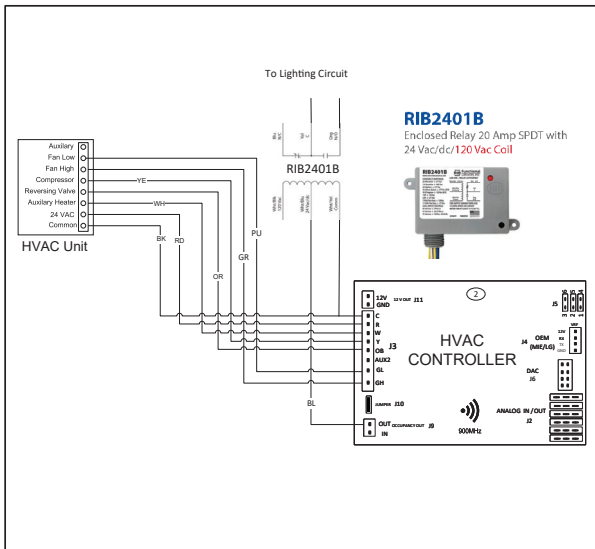

# Custom Energy Savings Settings

Setting Index	Max	Min
E1	001	000
E2	030	002
E3	020	010
E4	030	002
E5	060	000
E6	060	000
E7	060	000
E8	023	000
E9	023	000
10	060	000
11	082	062
12	120	000
13	072	052
14	092	072
15	082	062
16	084	064
17	082	060
18	001	000
19	004	000
20	001	000
21	001	000
22	NA	NA

# Custom Energy Savings Settings

Setting Index	Max	Min
23	020	004
24	001	000
25	030	005
26	001	000
27	070	055
28	075	065
29	NA	NA
30	001	000
31	060	001
32	008	002
33	010	002
34	050	-050
35	002	001
36	001	000
37	002	000

# Custom Energy Savings Settings

## 01 – FAN CONTROL MODE



Default value: 00  
Range: 00-01

00: AUTOMATIC - fan runs only when there is a demand for heating or air conditioning

01: CONTINUOUS - fan runs continuously when thermostat is on

# Custom Energy Savings Settings

## 02 – 1<sup>ST</sup> STAGE DIFFERENTIAL - HEAT



Default value: 0.5F  
Range: 0.2F - 3.0F

Select number of degrees thermostat has to sense between automatic changeover temperature for heat and room temperature before a call for 1st stage heating is initiated.

# Custom Energy Savings Settings

## 03 – 2<sup>ND</sup> STAGE DIFFERENTIAL - HEAT

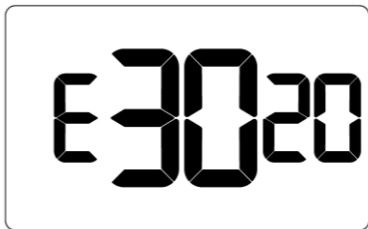

Default value: 2.0F  
Range: 1.0F - 2.0F

Select difference between 1st stage heating and 2nd stage heating initiation.

This also applies as the 3rd and 4th stage differential on top of the 2nd when there are more than 2 stages.

# Custom Energy Savings Settings

## 04 – 1ST STAGE DIFFERENTIAL - COOL



Default value: 0.5F  
Range: 0.2F - 3.0F

Select number of degrees thermostat has to sense between automatic changeover temperature for cool and room temperature before a call for 1st stage cooling is initiated.

# Custom Energy Savings Settings

## 05 – INCIDENTAL OCCUPANCY THRESHOLD



Default value: 5 minutes  
Range: 0 - 60 minutes

Select minimum period of time (in minutes) for which occupancy needs to be detected to enter guest occupancy mode. When occupancy is detected, thermostat will switch to occupied mode for a duration of Incidental Occupancy Threshold selected.

If occupancy is detected for a period of time shorter than the Incidental Occupancy Threshold selected, the thermostat will automatically revert to unoccupied mode at the end of the Incidental Occupancy Threshold period and continue to observe energy saving functions that were in effect before the room became occupied. This setting allows ignoring incidental room visits.

If occupancy is detected for a period of time longer than the Incidental Occupancy Threshold selected, the thermostat will enter the guest occupancy mode. When the thermostat is in the guest occupancy mode, it will revert to unoccupied mode and initiate the setback temperature only when occupancy is not detected for the duration of the setback delay (Heat or Cool) period.

# Custom Energy Savings Settings

## 06 – NIGHT OCCUPANCY THRESHOLD



Default value: 1 minute  
Range: 0 - 60 minutes

Select minimum period of time (in minutes) for which occupancy needs to be detected to consider the room occupied during the Night Occupancy period. When occupancy is detected during Night Occupancy Period for longer than the Night Occupancy Threshold selected, the thermostat will instantaneously switch to occupied mode.

If occupancy is detected for a period of time shorter than the Night Occupancy Threshold selected, the thermostat will automatically revert to unoccupied mode and continue to observe energy saving functions that were in effect before the room became occupied.

If occupancy is detected for a period of time longer than the Night Occupancy Threshold selected, the thermostat will disable the occupancy sensor and consider the room occupied until the end of the Night Occupancy period.

This feature ensures energy saving functions that may affect guest comfort will not come in effect during the Night Occupancy period.

# Custom Energy Savings Settings

## 07 – FORCED 2ND STAGE HEATING

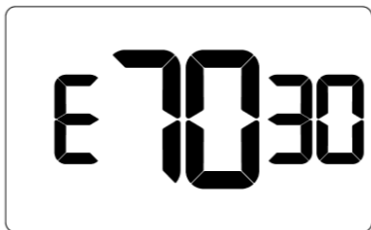

Default value: 30 minutes  
Range: 0 - 60 minutes

Select a number of minutes 1st stage heating will run before 2nd stage heating is automatically initiated if the guest set point is not reached and the 2nd stage heating is not initiated through differential settings.

This feature allows automatically turning on 2nd stage heating to avoid excessive compressor use. Set to 00 to disable the feature.

This also applies as the 3rd and 4th stage differential on top of the 2nd when there are more than 2 stages.

# Custom Energy Savings Settings

## 08 – NIGHT OCCUPANCY START



Default value: 21 hours  
Range: 0 - 23 hours

Select the start time (24-hour clock) for Night Occupancy

If occupancy is detected for a period of time longer than the Night Occupancy Threshold during Night Occupancy period, the thermostat will disable the occupancy sensor and consider the room occupied until the end of the Night Occupancy period.

This feature ensures that energy saving functions that may affect guest comfort will not come in effect during the Night Occupancy period if room was occupied for a period of time longer than Night Occupancy Threshold.

# Custom Energy Savings Settings

## 09 – NIGHT OCCUPANCY END



Default value: 9 hours  
Range: 0 - 23 hours

Select time (24-hour clock) for Night Occupancy to end.

The time of day the Night Occupancy ends and the thermostat switches back to the room sensing settings chosen in the other occupancy modes.

# Custom Energy Savings Settings

## 10 – TEMPERATURE RECOVERY TIME



Default value: 25 minutes  
Range: 0 - 60 minutes

Select the maximum time allowed for a HVAC unit to attain temperature as defined by Heat and Cool Recovery Temperature;

Temperature Recovery Time selected and the actual temperature recovery ability of the HVAC unit are used to calculate setback temperatures. Calculated setback temperatures maximize energy savings and at the same time ensures a comfortable room temperature (defined as Heat and Cool Recovery Temperature) will be restored within the selected Temperature Recovery Time.

Setting the Temperature Recovery Time to 00, disables temperature recovery. When temperature recovery is disabled, thermostat will use the Minimum and Maximum Setback Temperatures as setback set points.

# Custom Energy Savings Settings

## 11 – RECOVERY TEMPERATURE - HEAT

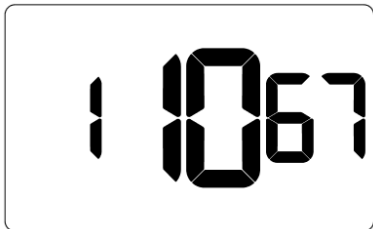

Default value: 67F  
Range: 62F - 82F

Select room temperature in °F that a HVAC unit will have to attain within the selected Temperature Recovery Time when there is a need for heating.

If recovery is disabled (Temperature Recovery Time set to 0) or if setback temperatures have not yet been calculated, the Recovery Temperature - Heat value will be used as the setback temperature for heating.

# Custom Energy Savings Settings

## 12 – TEMPERATURE SETBACK DELAY



Default value: 20  
minutes  
Range: 0 - 120 minutes

Select the time delay (in minutes) for which the room that is in the guest occupancy mode needs to be unoccupied before the temperature setback is initiated.

This feature prevents initiating temperature setback prematurely while the guest is still in the room but in an area where occupancy cannot be detected by the occupancy sensor.

Setting the Temperature Setback Delay - Heat to 00, disables the setback in the heat mode. Set to 00 to disable EMS.

# Custom Energy Savings Settings

## 13 – MINIMUM SETBACK TEMPERATURE - HEAT



Default value: 64F  
Range: 52F - 72F

Select Minimum Setback Temperature in °F.

Setback temperature is calculated by measuring HVAC unit's ability to attain Recovery Temperature - Heat within Temperature Recovery Time.

If recovery is disabled (Temperature Recovery Time is set to 0) or if setback temperatures have not yet been calculated, the Recovery Temperature - Heat value will be used as the setback temperature for heating.

If calculated setback temperature for heating is lower than Minimum Setback Temperature, then the Minimum Setback Temperature will be used as setback temperature for heating.

This feature allows defining the minimum temperature in a room when room is unoccupied and the thermostat is in the setback mode.

# Custom Energy Savings Settings

## 14 – MAXIMUM SETBACK TEMPERATURE



Default value: 78F  
Range: 72F - 92F

Select the Maximum Setback Temperature in °F.

Setback temperature is calculated by measuring HVAC unit's ability to attain Recovery Temperature - Cool within Temperature Recovery Time.

If recovery is disabled (Temperature Recovery Time is set to 0) or if setback temperatures have not yet been calculated, the Maximum Setback Temperature value will be used as the setback temperature for cooling.

If calculated setback temperature for air conditioning is higher than Maximum Setback Temperature, then the Maximum Setback Temperature will be used as setback temperature for air conditioning.

This feature allows defining the maximum temperature in a room when room is unoccupied and the thermostat is in the setback mode.

# Custom Energy Savings Settings

## 15 – RECOVERY TEMPERATURE - COOL



Default value: 74F  
Range: 62F - 82F

Select the room temperature in °F that a HVAC unit will have to attain within the selected Temperature Recovery Time when there is a need for air conditioning.

# Custom Energy Savings Settings

## 16 – MINIMUM SET POINT



Default value: 66F  
Range: 64F - 84F

Select the minimum set point in °F that a guest can select.

# Custom Energy Savings Settings

## 17 – MAXIMUM SET POINT



Default value: 78F  
Range: 60F - 82F

Select the maximum set point in °F that a guest can select.

# Custom Energy Savings Settings

## 18 – TEMPERATURE CONTROL MODE

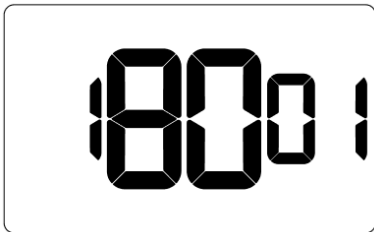

Default value: AUTOMATIC  
Range: 00 - 01

Select Temperature Control Mode:

00: MANUAL - Allows users to select HEAT only or COOL only temperature control mode to maintain the room temperature

01: AUTOMATIC - Thermostat automatically turns on heating or air conditioning to maintain the room temperature at the selected temperature set point

# Custom Energy Savings Settings

## 19 – AUTO CHANGEOVER SET POINT OFFSET



Default value: 1F  
Range: 1F - 4F

Select the difference between the guest-selected set point and the heat and the cool set point when the thermostat is in the automatic temperature control mode.

This value plus the 1st stage differential defined in steps 2 and 4, defines the temperature at which the thermostat would automatically change heating/cooling modes.

This feature allows adjusting the deadband between the heat and the cool set points in automatic changeover mode in to avoid the system from bouncing back and forth between heating and cooling under normal operating conditions.

# Custom Energy Savings Settings

## 20 – SETBACK SET POINTS



Default value: 01  
Range: 00 - 01

00: When room is unoccupied and the thermostat is in the setback mode or turned off, it will NOT maintain the temperature between heat and cool setback set points.

01: When room is unoccupied and the thermostat is in the setback mode or turned off, it will maintain the temperature between heat and cool setback set points.

# Custom Energy Savings Settings

## 21- AUTO-RESTORE



<p>Default value: 01 Range: 00 - 01</p>	<p>00: When guest enters the room, the thermostat will be turned off - it will not automatically restore the most recent guest settings</p> <p>01: When guest enters the room, the thermostat will automatically restore the most recent guest settings</p>
---	---

# Custom Energy Savings Settings

22 – PLACEHOLDER SCREEN

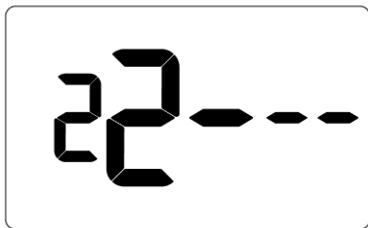

NOTE: for future use

# Custom Energy Savings Settings

## 23 – SETPOINT OVERSHOOT

A digital display showing the number 23006 in a large, black, seven-segment font. The display is contained within a rounded rectangular border.

Default value: 0.6F  
Range: 4F - 20F

Select the °F of overshoot above or below the setpoint on the thermostat before the thermostat stops the call for cooling or heating.

# Custom Energy Savings Settings

## 24 – AUTOMATIC HUMIDITY CONTROL



Default value: 00  
Range: 00 - 01

00: Disable automatic humidity control  
01: Enable automatic humidity control

When Automatic Humidity Control is enabled, thermostat will turn on air conditioning in an unoccupied room when humidity raises above 60% and room temperature is above 72°F until either room humidity is below 55% or room temperature is below 72°F

This setting is active only on thermostats with enabled humidity features. Changing this setting on a non-humidity thermostat will have no effect on thermostat operation.

Humidity features can be enabled on compatible thermostats via online management.

# Custom Energy Savings Settings

## 25 – 2ND STAGE COOL DIFFERENTIAL



Default value: 2F  
Range: 5F - 30F

Select the °F differential required to trigger 2nd stage cooling (if applicable).

This also applies as the 3rd and 4th stage differential on top of the 2nd when there are more than 2 stages.

# Custom Energy Savings Settings

## 26 – SMART SETBACK



Default value: 00  
Range: 00 - 01

Smart setback reduces the excessive heating or cooling that may occur when occupants set their thermostats to setpoints outside of the norm. Occupant setpoint that is greater than Cool Setback or less than Heat Setback will be respected during setbacks to save energy.

# Custom Energy Savings Settings

## 27 – HUMIDITY CONTROL THRESHOLD



Default value: 60F  
Range: 55F - 70F

Select the relative humidity level that automatic humidity control will attempt to control in conjunction with the humidity cut-off temp.

# Custom Energy Savings Settings

## 28 – HUMIDITY CUTOFF TEMPERATURE



Default value: 72F  
Range: 65F - 75F

Select the temperature at which humidity control will shut off.

# Custom Energy Savings Settings

29- PLACEHOLDER SCREEN

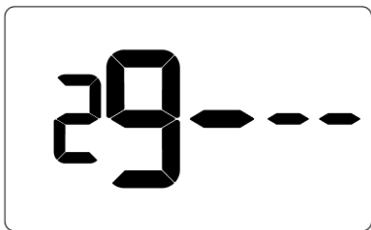

NOTE: for future use

# Custom Energy Savings Settings

30- ENERGY MANAGEMENT ON/OFF



Default value: 01  
Range: 00 - 01

00: Energy management disabled  
01: Energy management enabled

# Custom Energy Savings Settings

## 31- DOOR/WINDOW SHUT OFF DELAY



Default value: 2  
Range: 1 - 60

Select the time delay (in minutes) before the thermostat disables air conditioning when a door or window sensor has been installed.

# Custom Energy Savings Settings

## 32- AUTO FAN SPEED 1ST STAGE DIFFERENTIAL



Default value: 2F  
Range: 1F - 8F

Select the °F differential between Low Fan and 2nd stage fan (Medium or High) when Auto-Fan Speed is selected.

# Custom Energy Savings Settings

## 33- AUTO FAN SPEED 2ND STAGE DIFFERENTIAL



Default value: 4F  
Range: 2F - 10F

Select the °F differential between Medium and High Fan when Auto-Fan Speed is selected (only active if 3 fan speeds are available).

# Custom Energy Savings Settings

## 34 – TEMPERATURE CALIBRATION



Default value: 0F  
Range: -5F - 5F

Calibrate the temperature display

# Custom Energy Savings Settings

## 35 – AUTOMODETYPE



Default value: 01  
Range: 01 - 02

01: Standard Auto Mode - The thermostat will apply the deadband on the guest setpoint and control temperature with the guest setpoint as the median

02: Changeover Auto Mode - The thermostat will apply the deadband as a changeover limit where the deadband is crossed triggering a change in heating or cooling mode

# Custom Energy Savings Settings

## 36 – HUMIDITY CONTROL OCCUPIED ROOM



<p>Default value: 00 Range: 00 - 01</p>	<p>00: Humidity control OFF - The thermostat will disable humidity control when the room is occupied</p> <p>01: Humidity control ON - The thermostat will enable humidity control even when the room is occupied</p>
---	--

# Custom Energy Savings Settings

## 37 – HEAT EQUIPMENT LOCKOUT



<p>Default value: 00 Range: 00 - 02</p>	<p>00: Compressor lockout - If set to 1, the thermostat will only allow electric heat</p> <p>01: Electric heat lockout - If set to 2, the thermostat will only allow compressor heat.</p> <p>02: Equipment lockout is disabled - The thermostat will enable both compressor and electric heat</p>
---	---

# Troubleshooting

## Restoring Factory Settings

For reported errors or configuration issues, restore settings to thermostat default parameters and re-pair with HVAC Controller.

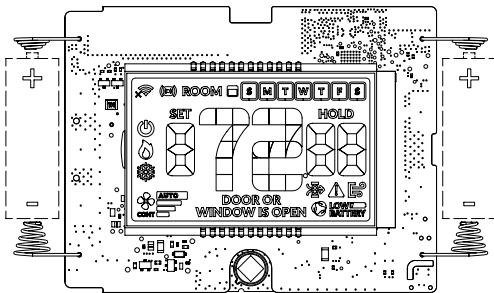

1. Press and hold the FAN and SYSTEM MODE buttons together for 3 seconds to enter meshID screen
2. Press SETTINGS to navigate to clock configuration screen.
3. Press and hold FAN and SYSTEM MODE buttons until thermostat displays RST, then press SETTINGS button
4. Verify thermostat displays SETUP after three (3) seconds and reconfigure thermostat

Contact technical support if the issues are not resolved.

# APPENDIX 1 - Energy Saving Presets

Bolded values below indicate the factory default profile\*

	Level 0*	Level 1	Level 2	Level 3	Level 4	Level 5
Fan Control Mode	AUTO	AUTO	AUTO	AUTO	AUTO	AUTO
1st Stage Differential Heat	005	005	005	005	005	005
2nd Stage Differential Heat	010	010	010	020	020	020
1st Stage Differential Cool	005	005	005	005	005	005
Guest Occupancy Threshold	000	005	005	005	005	005
Night Occupancy Threshold	001	001	001	001	001	001
Force 2nd Stage Heating After	030	030	030	030	030	030
Night Occupancy Start	018	019	020	021	022	023
Night Occupancy End	012	011	010	009	008	007
Temperature Recovery Time	000	015	020	025	030	000
Recovery Temperature Heat	070	069	068	067	066	065
Temperature Setback Delay	000	030	025	020	015	010
Minimum Setback Temperature	067	066	065	064	063	062
Maximum Setback Temperature	072	074	076	078	080	082
Recovery Temperature Cool	071	072	073	074	075	076
Minimum Set point	064	064	065	066	067	068
Maximum Set point	082	082	080	078	076	074
Temperature Control Mode	AUTO	AUTO	AUTO	AUTO	AUTO	AUTO
Auto Changeover Set Point Offset (Dead Band)	001	001	001	001	001	001

# APPENDIX 1 - Energy Saving Presets

	Level 0	Level 1	Level 2	Level 3	Level 4	Level 5
Setback Set Points	OFF	ON	ON	ON	ON	ON
Auto Restore	OFF	ON	ON	ON	ON	ON
N/A						
Setpoint Overshoot	006	006	006	006	006	006
Automatic Humidity Control	OFF	OFF	OFF	OFF	OFF	OFF
2nd Stage Cool Differential	010	010	010	020	020	020
Smart Setback	OFF	OFF	OFF	OFF	OFF	OFF
Humidity Control Threshold	060	060	060	060	060	060
Humidity Cutoff Temperature	072	072	072	072	072	072
N/A						
Energy Management On/Off	OFF	ON	ON	ON	ON	ON
Door/Window Shutoff Delay	002	002	002	002	002	002
Auto Fan Speed 1st Stage Differential	002	002	002	002	002	002
Auto Fan Speed 2nd Stage Differential	004	004	004	004	004	004
Temperature Calibration	000	000	000	000	000	000
Automode Type	STD	STD	STD	STD	STD	STD
Humidity Control Occupied Room	OFF	OFF	OFF	OFF	OFF	OFF
Heat Equipment Lockout	000	000	000	000	000	000

## APPENDIX 2 - Equipment Codes

	Outputs						
EQPT Code	J3 port						J9 port
Color	White	Yellow	Orange	Purple	Green	Brown	Blue
0101	W1	X	X	X	GH	X	OCC
0102	W1	X	X	GL	GH	X	OCC
0103	W1	X	GM	GL	GH	X	OCC
0302	GH	WCW	WCCW	GL	X	X	OCC
0303	GH	WCW	WCCW	GL	GM	X	OCC
1001	X	Y1	O	X	GH	X	OCC
1002	X	Y1	O	GL	GH	X	OCC
1011	X	Y1	B	X	GH	X	OCC
1012	X	Y1	B	GL	GH	X	OCC
1101	W1	Y1	O	X	GH	X	OCC
1102	W1	Y1	O	GL	GH	X	OCC
1111	W1	Y1	B	X	GH	X	OCC
1112	W1	Y1	B	GL	GH	X	OCC
1201	WAUX	Y1	O	X	GH	X	OCC
1202	WAUX	Y1	O	GL	GH	X	OCC
1211	WAUX	Y1	B	X	GH	X	OCC
1212	WAUX	Y1	B	GL	GH	X	OCC
2001	X	Y1	X	X	GH	X	OCC
2002	X	Y1	X	GL	GH	X	OCC
2003	X	Y1	GM	GL	GH	X	OCC
2100	W1	Y1	X	X	X	X	OCC
2101	W1	Y1	X	X	GH	X	OCC

## APPENDIX 2 - Equipment Codes

	Outputs							
EQPT Code	J3 port							J9 port
Color	White	Yellow	Orange	Purple	Green	Brown	Blue	
2102	W1	Y1	X	GL	GH	X	OCC	
2103	W1	Y1	GM	GL	GH	X	OCC	
2106	W1	Y1	X	X	X	X	OCC	
2502	Y1	W1	W2	GL	GH	X	OCC	
5501	Y1	Y2	W1	W2	GH	X	X	
5502	Y1	Y2	W1	W2	GH	X	GL	

	Outputs								Analog output Connections (J6 Port)			
EQPT Code	J3 port							J9 port	O0	GND	O1	O2
Color	White	Yellow	Orange	Purple	Green	Brown	Blue	White	Black	Yellow	Green	
4403	X	X	GM	GL	GH	X	OCC	Analog Heat	GND	Analog Cool	X	
4406	X	X	X	X	X	X	OCC	Analog Heat	GND	Analog Cool	Analog Fan	

# APPENDIX 3 - Glossary

"Automatic Fan Control Mode" - fan runs only when there is a demand for heating or cooling;

"Manual Fan Control Mode" - guest can select between automatic or continuous fan operation;

"Minimum Set point" - minimum temperature that a guest can request;

"Maximum Set point" - maximum temperature that a guest can request;

"Auto Changeover Set Point Offset" - the difference between the guest-selected set point and the heat and cool changeover temperatures;

"1st Stage Differential - Heat" - the temperature that the thermostat has to sense between the automatic changeover temperature for heat and the room temperature before a call for the 1st stage heating is initiated;

"2nd Stage Differential - Heat" - difference between 1st stage heating temperature and room temperature before the 2nd stage heating is initiated;

"1st Stage Differential - Cool" - the temperature that the thermostat has to sense between the automatic changeover temperature for cool and the room temperature before a call for the 1st stage cooling is initiated;

"Forced 2nd Stage Heating" - number of minutes 1st stage heating will run before 2nd stage heating is automatically initiated if the guest set point is not reached and the 2nd stage heating is not initiated through differential settings

"Temperature Recovery Time" - the maximum period of time allowed for restoring the "Recovery Temperature";

"Recovery Temperature" - the room temperature that needs to be restored within the "Temperature Recovery Time";

"Maximum Setback Temperature" - the highest room temperature allowed when thermostat is in the setback mode;

"Minimum Setback Temperature" - the lowest room temperature allowed when thermostat is in the setback mode;

"Temperature Setback Delay" - the length of time for which the room that is in the guest occupancy mode needs to be unoccupied before the temperature setback is initiated;

Incidental Occupancy Threshold - the minimum period of time (in minutes) for which occupancy needs to be detected in order to enter the "Guest Occupancy" mode;

Night Occupancy Threshold - the minimum period of time during the Night Occupancy period for which occupancy needs to be detected in order to enter the Night Occupancy mode;

Night Occupancy Period - The period of time during the day during which the Night Occupancy mode can be activated if occupancy longer than the Night Occupancy Threshold is detected;

"Auto Restore On" - thermostat will restore the most recent guest settings when new occupancy is detected;

"Auto Restore Off" - thermostat will NOT restore the most recent guest and will remain turned off settings when new occupancy is detected;

"Setback Set points On" - thermostat will maintain setback temperatures when room is unoccupied;

"Setback Set points Off" - thermostat will NOT maintain setback temperatures when room is unoccupied;

---

"Incidental Occupancy" - occupancy shorter than the Incidental Occupancy Threshold;

"Guest Occupancy" - occupancy longer than the Incidental Occupancy Threshold;

"Temperature Setback" - thermostat maintains setback temperatures and not the guest set point temperature in order to save energy;

"Night Occupancy Mode" - thermostat status during which setback mode is disabled if occupancy longer than Night Occupancy Threshold is detected within the "Night Occupancy" period;

"Automatic Temperature Changeover" - thermostat automatically activates heating or cooling to maintain the desired room temperature;

"External Thermostat" (Class 2) mode - HVAC unit setting allowing it to be controlled by a remote thermostat;

# Warranty Information

Refer to [www.verdant.co/verdant-warranty](http://www.verdant.co/verdant-warranty) information.

# Technical Specifications

Product Type

Thermostat

White Model	Black Model	Description
<b>VRPXEMWRTA4</b>	<b>VRPXEMWRTB4</b>	<b>RS-485 12VDC Communicating</b>
<b>DSSXEMWRTA4</b>	<b>N/A</b>	<b>DSS 12VDC Communicating</b>
Wireless Frequency	902-928MHz	
Case Dimensions	5.60 x 3.46" x 0.937" (142.3mm x 88mm x 23.8mm)	
Screen Dimensions	2.60" x 1.5" (66.1mm x 38.1mm)	
Operating Voltage	2 x 1.5VDC AA Alkaline Non-rechargeable Batteries - Not Supplied 24VAC or 12VDC	
Control Outputs (24VAC)  (1.5A maximum per terminal, 2.5A maximum all terminals combined)	N/A	
Power Supply Outlet	N/A	
Occupancy Sensor Detection Range	Horizontal (FOV 100°)	
Temperature Accuracy	±1°F	
Enclosure Material	SABIC PC/ABS CYCOLOY C2800	
Ambient Operating Temp	32°F -105°F   0 - 41°C	
Internet Connectivity	N/A	
FCC ID	2A4JN-VX4001	
IC	28229-VX4001	

# Technical Specifications

## Technical Specifications for Thermostats (cont'd)

Product Type	HVAC Controller	Gateway
SKU(s)	EMCC6R4	EMOCT4
Wireless Frequency	902-928MHz	N/A
Case Dimensions	4.08" x 2.76" x 1.02" 104mm x 70mm x 26mm	4.72" x 3.15" x 1.18" 120mm x 80mm x 30mm
Operating Voltage	24VAC (20-30VAC)   12VDC (9-15VDC)	12VDC 1.5A

# Technical Specifications

## Technical Specifications for HVAC Controller (cont'd)

Product Type	HVAC Controller	Gateway	
Control Outputs (24VAC/12VDC)  (1.5A maximum per terminal, 2.5A maximum all terminals combined)	Common (J3-C)	N/A	
	24 VAC (J3-R)		
	Heat (J3-W)		
	Compressor (J3-Y)		
	Reversing Valve (J3-OB)		
	Auxiliary (J3-AUX2) /		
	Fan Low (J3-GL) / AUX1 In (J9)		
	Fan High (J3-GH) / AUX1 Out (J9)		
	N/A / RS485A		
	N/A / RS485B		
N/A / 12 VDC (J11)			
N/A / GND (J11)			
Power Supply Outlet	12VDC @ 0.05A (Max)	N/A	N/A
Occupancy Sensor Beam Width	N/A	N/A	N/A
Temperature Accuracy	±1°F	N/A	N/A
Enclosure Material	ABS+PC (TAIRILOY® AC3100 (Formosa Chemicals & Fibre Corporation))	Extruded Aluminum	
Ambient Operating Temp	32°F -105°F   0 - 41°C	32°F -105°F   0 - 41°C	
Internet Connectivity	N/A	100M/1000M Base-T Ethernet	
FCC ID	XEY-ZX-LV		
IC	8410A-ZX-LV		

# Technical Specifications

Product Type	Root Node	Sensors
SKU(s)	ZX-RN	EMRWOS4 EMRDS4 EMRTS4
Wireless Frequency	902-928MHz	902-928MHz
Case Dimensions	2.4" x 1.54" x 0.78" 46mm x 61mm x 19mm	1.82" x 2.4" x 0.74" 46mm x 61mm x 19mm
Operating Voltage	+5VDC (nom.)	2 1.5VDC AAA Alkaline Non-rechargeable Batteries - Not Supplied
Control Outputs (24VAC)  (1.5A maximum per terminal, 2.5A maximum all terminals combined)	N/A	N/A
Power Supply Outlet	N/A	N/A
Occupancy Sensor Beam Width	N/A	±47° (94°)
Temperature Accuracy	±1°F	±1°F
Enclosure Material	ABS (AF312C(LG CHEM))	ABS+PC (TAIRILOY® AC3100 (Formosa Chemicals & Fibre Corporation))
Ambient Operating Temp	32°F -105°F   0 - 41°C	32°F -105°F   0 - 41°C
Internet Connectivity	N/A	N/A
FCC ID	XEY-ZX-RN	XEYZ9RF
IC	8410A-ZXRN	8410A-Z9RF



THIS DEVICE COMPLIES WITH PART 15 OF THE FCC RULES. OPERATION IS SUBJECT TO THE FOLLOWING TWO CONDITIONS: (1) THIS DEVICE MAY NOT CAUSE HARMFUL INTERFERENCE, AND (2) THIS DEVICE MUST ACCEPT ANY INTERFERENCE RECEIVED, INCLUDING INTERFERENCE THAT MAY CAUSE UNDESIRE OPERATION.

THE MANUFACTURER IS NOT RESPONSIBLE FOR ANY RADIO OR TV INTERFERENCE CAUSED BY UNAUTHORIZED MODIFICATIONS TO THIS EQUIPMENT. SUCH MODIFICATIONS COULD VOID THE USER'S AUTHORITY TO OPERATE THE EQUIPMENT

This device complies with Industry Canada license-exempt RSS standard(s). Operation is subject to the following two conditions: (1) this device may not cause interference, and (2) this device must accept any interference, including interference that may cause undesired operation of the device.

Le présent appareil est conforme aux CNR d'Industrie Canada applicables aux appareils radio exempts de licence. L'exploitation est autorisée aux deux conditions suivantes : (1) l'appareil ne doit pas produire de brouillage, et (2) l'utilisateur de l'appareil doit accepter tout brouillage radio électrique subi, même si le brouillage est susceptible d'en compromettre le fonctionnement.

Under Industry Canada regulations, this radio transmitter may only operate using an antenna of a type and maximum (or lesser) gain approved for the transmitter by Industry Canada. To reduce potential radio interference to other users, the antenna type and its gain should be so chosen that the equivalent isotropically radiated power (e.i.r.p.) is not more than that necessary for successful communication.

Conformément à la réglementation d'Industrie Canada, le présent émetteur radio peut fonctionner avec une antenne d'un type et d'un gain maximal (ou inférieur) approuvé pour l'émetteur par Industrie Canada. Dans le but de réduire les risques de brouillage radioélectrique à l'intention des autres utilisateurs, il faut choisir le type d'antenne et son gain de sorte que la puissance isotroperayonnée équivalente (p.i.r.e.) ne dépasse pas l'intensité nécessaire à l'établissement d'une communication satisfaisante.

COVERED BY ONE OR MORE OF THE FOLLOWING PATENTS. US PATENTS: 8,369,994; 8,141,791; 7,918,406; 7,232,075; 7,185,825; 7,156,318; 7,152,806; 7,145,110; 7,050,026; 7,028,912; 6,902,117; 6,789,739; 6,786,421; 6,619,555; 6,581,846; 6,578,770; 7,838,803; 7,841,542; D556,061; D518,744; RE40,437; CANADIAN PATENTS: 2,633,113; 2,633,200; OTHER PATENTS PENDING.

Verdant Environmental Technologies, Inc. reserves the right to make changes, without notice, in design or components. Product appearance may vary. © Verdant Environmental Technologies, Inc. 2024.

Printed in Canada. NOVEMBER 2024

TECHNICAL SUPPORT: [verdant.support@copeland.com](mailto:verdant.support@copeland.com) 1-877-318-1823

**PTAC DIRECT SALES, INC.**  
**185 S. KIMBALL AVE., SUITE 130**  
**SOUTHLAKE, TX 76092**  
**877.454.7822**  
**[www.PTACdirect.com](http://www.PTACdirect.com)**